



# PF/SF Bins

## ICE STORAGE BIN SERIES



PF/SF Bins  
02/01/17  
Item # 13163

Item #: \_\_\_\_\_  
 Project: \_\_\_\_\_  
 Qty: \_\_\_\_\_  
 AIA#: \_\_\_\_\_

**PF - PVC Coated Galvanized Steel Finish**  
**SF - Stainless Steel Finish**



B-250PF

B-300PF  
B-300SF  
BD-300PF  
BD-300SF

B-500PF  
B-500SF  
BD-500PF  
BD-500SF



B-700PF  
B-700SF

B-800PF  
B-800SF

B-900PF  
B-900SF

### Features

- ▶ Protected by H-GUARD Plus Antimicrobial Agent 
- ▶ Polyethylene bin liner for sanitary storage
- ▶ Sturdy construction for side-by-side or stacked ice machine installation

- Ice storage capacity from 250 lbs. up to 900 lbs.
- Both surfaces are designed for easy cleaning
- Long lasting attractive appearance
- Foamed-in-place polyurethane insulation, in all bin walls and bottom, provides dependable ice storage

### BD Bins

- Fit 24" - 24 1/2" deep ice machine without top kit extension



### Warranty:

2 Year Parts & Labor (Production prior to January 2012)  
 3 Year Parts & Labor (Production January 2012 and after)  
 Valid in United States, Canada, Puerto Rico and U.S. Territories. Contact factory for warranty in other countries.

Model Number	Exterior Dimensions W x D x H*	Maximum Storage Capacity	Cubic Volume cu ft <sup>3</sup>	Interior Dimensions W x D x H*	Shipping Weight
B-250PF	30" x 32 <sup>1/2</sup> " x 33 <sup>3/8</sup> "	250 lbs.	10.30 ft <sup>3</sup>	27 <sup>1/10</sup> " x 27 <sup>7/10</sup> " x 23 <sup>7/10</sup> "	130 lbs.
B(D)-300PF/SF	22" x 32 <sup>1/2</sup> " x 46"	300 lbs.	11.51 ft <sup>3</sup>	19 <sup>1/10</sup> " x 27 <sup>7/10</sup> " x 37 <sup>3/5</sup> "	135 lbs.
B(D)-500PF/SF	30" x 32 <sup>1/2</sup> " x 46"	500 lbs.	16.33 ft <sup>3</sup>	27 <sup>1/10</sup> " x 27 <sup>7/10</sup> " x 37 <sup>3/5</sup> "	155 lbs.
B-700PF/SF	44" x 32 <sup>1/2</sup> " x 46"	700 lbs.	24.77 ft <sup>3</sup>	41 <sup>1/10</sup> " x 27 <sup>7/10</sup> " x 37 <sup>3/5</sup> "	200 lbs.
B-800PF/SF	48" x 32 <sup>1/2</sup> " x 46"	800 lbs.	27.18 ft <sup>3</sup>	45 <sup>1/10</sup> " x 27 <sup>7/10</sup> " x 37 <sup>3/5</sup> "	210 lbs.
B-900PF/SF	52" x 32 <sup>1/2</sup> " x 46"	900 lbs.	29.59 ft <sup>3</sup>	49 <sup>1/10</sup> " x 27 <sup>7/10</sup> " x 37 <sup>3/5</sup> "	220 lbs.

\*Height includes 6" legs



# PF/SF Bins

## ICE STORAGE BIN SERIES



PF/SF Bins  
02/01/17  
Item # 13163

### Ice Machine Model Application

Bins	22" Width KM-340M KM-515M KM-600M KM-650M F-450M F-801M F-1002M	22" Width KMD-410M KMS-822M FD-650M-C FD-1002M-C	30" Width KM-901M KM-1340M KM-1601M KML Series F-1501M F-2001	30" Width KMD-460M KMD-530M KMD-850M KMD-901MRH KMD-901MWH KMS-1401M* KMS-2000M*	44" Width 2 KM-340M 2 KM-515M 2 KM-600M 2 KM-650M 2 F-450M 2 F-801M 2 F-1002M	44" Width 2 KMD-410M 2 KMS-822M 2 FD-650M-C 2 FD-1002M-C	48" Width KM-1301S KM-1400S KM-1601S KM-1900S KM-2100S KM-2500S
Bins B-300PF/SF	NO TOP KIT NEEDED	N/A	N/A	N/A	N/A	N/A	N/A
Bins B-250PF B-500PF/SF	NEED HS-2033	NEED HS-2033 & HS-2129	NO TOP KIT NEEDED	(B-250PF) NEED HS-2129 (B-500PF/SF) NO TOP KIT NEEDED	N/A	N/A	N/A
Bins B-700PF/SF	NEED HS-2035	NEED HS-2035 & HS-2130	NEED HS-2034	NEED HS-2034 & HS-2130	NO TOP KIT NEEDED	NEED HS-2130	N/A
Bins B-800PF/SF	NEED HS-2035 & HS-2032	NEED HS-2035 & HS-2132/ 2131	NEED HS-2034 & HS-2032	NEED HS-2131 & HS-2034/2032	NEED HS-2032	NEED HS-2130 & HS-2131	NO TOP KIT NEEDED
Bins B-900PF/SF	NEED HS-2035 & HS-2033	NEED HS-2035 & HS-2033/ HS-2132	NEED HS-2035	NEED HS-2132 & HS-2035	NEED HS-2033	NEED HS-2033 & HS-2132	NEED HS-2032

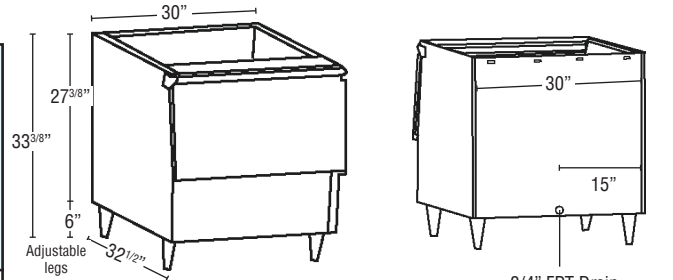

B-250PF

3/4" FPT Drain



B-300PF/SF  
BD-300PF/SF

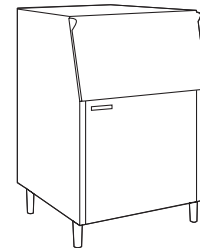

B-500PF/SF  
BD-500PF/SF

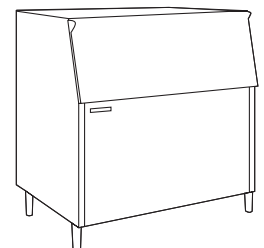

B-700PF/SF

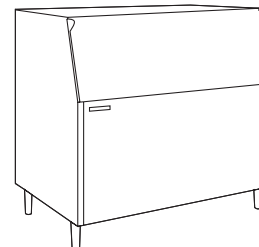

B-800PF/SF

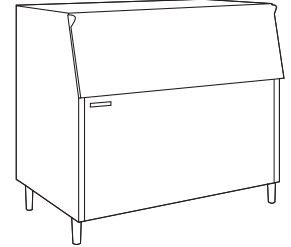

B-900PF/SF

BD Bins fit 24" - 24 1/2" deep ice machine without Top Kit extension.

BD-300PF/SF: KMD-410M, KMS822M, FD-650M-C, FD-1002M-C

BD-500PF/SF: KMD-460M, KMD-530, KMD-850, FD-650M-C

\* Any KMS or FD on bin need Top Kit Extension:

- HS-2129 - for use with B-500 bins
- HS-2130 - for use with B-700 bins
- HS-2131 - for use with B-800 bins
- HS-2132 - for use with B-900 bins

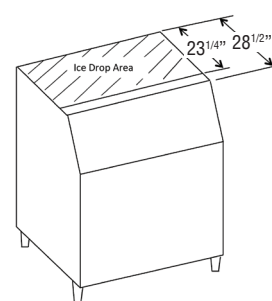
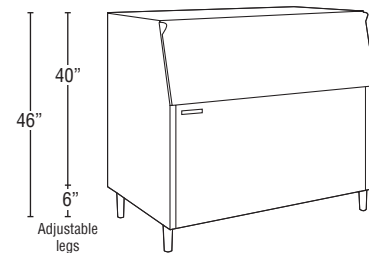
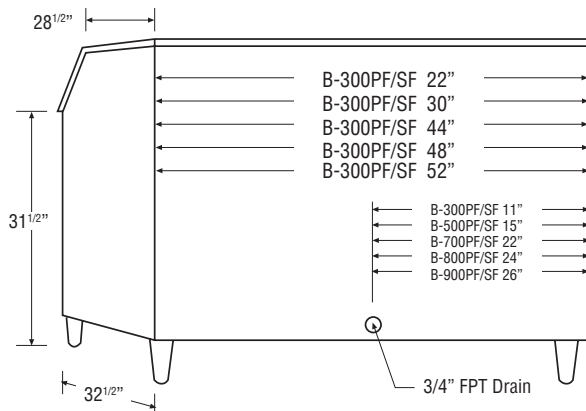

B Bins  
Top View

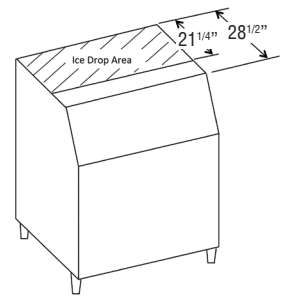

BD Bins  
Top View